



SLM - Product Overview

Non-Contact Discrete Part Length Measurement
Length-Section Light Scanner SLM

Product Overview
Q1/2019 - Version 1.0

Product Information

The SLM system is used for non-contact checking of the length of discrete parts such as profiles, pipes, sheets and plates. The measurement is usually carried out directly after a cutting unit, during regular transportation, without interrupting the production process. With right-angled object edges, as well as straight running of the parts, SLM achieves a measuring accuracy of typically ± 0.1 mm/m.

The SLM length-section light scanner operates in through light and therefore almost independent of the measurement material with consistently high accuracy and does not have to be parameterized or set up for new articles. Two different types of SLM systems are available:

SLM

Depending on the system length, parts with a length of 10 mm up to 4,860 mm can currently be measured with the standard SLM systems. The standard SLM system is always slightly longer than the longest test part to be measured.

SLM/2

The two-parted SLM/2 gauges are used for the length check of parts longer than 5 m up to a maximum of approx. 15 m, or when no continuous SLM standard arrays can be used. The measuring range of the SLM/2 is 4.5 m in maximum. Subsystem A of the sensor (red housing) is used to detect the end edge of the material. The subsystem B for detection of the leading material edge is available for the measuring ranges from 0.4 m + x to max. 4.5 m + x, whereby the offset length "x" stands for the distance between subsystem A and subsystem B. This means, for example, that part lengths of 3 m to 7.5 m or 10 m to 14.5 m can be measured. SLM/2 is generally installed permanently. However, it is also possible to attach one of the two pairs of transmitted light lines so that it can be moved in order to increase the length measuring range.



Fig. 1: SLM gauge



Fig. 2: SLM/2 gauge, consisting of subsystem A with red housing (left) and subsystem B (right)



Fig 3: SLM Components of portable system



Fig. 4: SLM components for fix system integration including sorting control

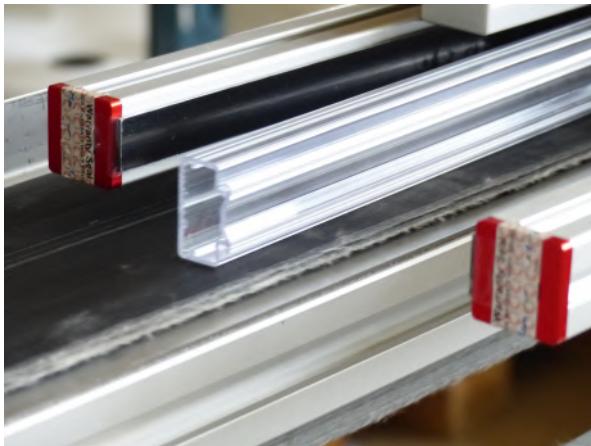

Fig. 5: Measurement of transparent profiles



Fig. 6: Measurement of extruded tubes

System Function

Figure 7 shows an example integration of the SLM system into a cutting system. The part length is measured directly after cutting, during regular transportation on the conveyor. SLM allows that several short parts in a row can be located in the measuring range. A gap of at least 10 mm in between the parts is necessary.

The customer-owned machine control or the optional SLM PLC from ELOVIS compares the measured values with the length and tolerance specification and controls the sorting into good and bad parts.

In confined spaces after cutting, or for long parts, a lateral discharge of the measured parts within the SLM arrays is possible. For this purpose, one of the two sensor arrays, by the use of a c-frame hangs freely placed next to the conveyor. This creates a gap between conveyor belt and sensor array, which allows a lateral discharge of the parts.

The SLM/2 gauge with two-parted transmitter and receiver arrays uses the same measurement principle as the standard SLM system, but the SLM/2 consists of two separate cable-connected transceiver pairs.

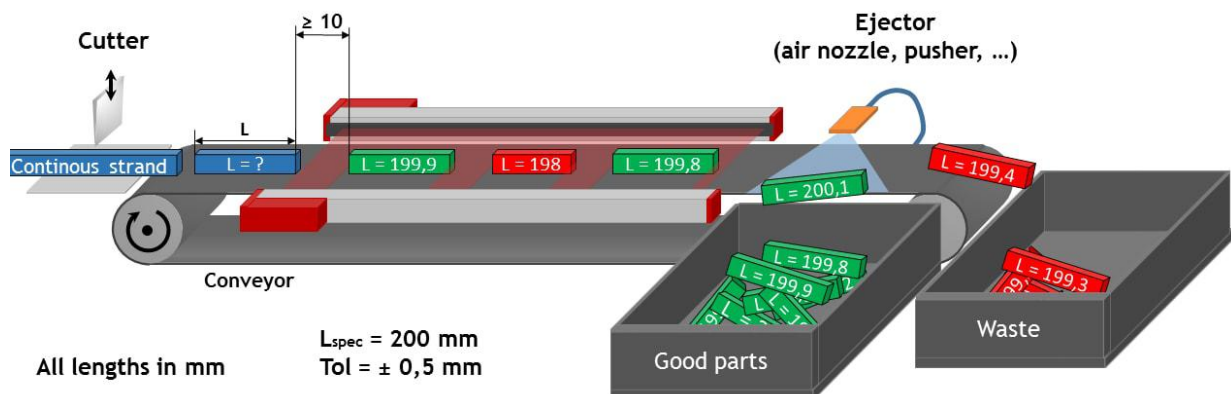

Fig. 7: Schematic drawing of the SLM system with sorting unit (Integration example)

Practical Experience

Thanks to the 100% control of the parts to be measured with the SLM gauge, complaints or returns due to length deviations are a thing of the past.

The setting of the cutting unit is simplified. Reason is that the operator receives a length value already from the first cut and thus can adjust the length fast and safely to the desired dimension.

The automated measurement of the length excludes errors due to operator influences during manual random sample tests and thus leads to increased process reliability.

Deviations from nominal lengths, e.g. due to a dulling knife or slippage in the feeder or in the pull-off device, are detected immediately and not only when samples are taken.

A measurement record can be created for each batch of production. Thus the compliance with the required customer tolerances can be proved and documented.

Finally the SLM system contributes to a reduction of rejects and increase of yield.

Measurement Objects

Pipes and tubes

e.g. tube, corrugated pipes, fuel and air pipes, hydraulic and medical tubes, hoses...

Sealing profiles

e.g. door and windows sealings, edge protection, engine sealings...

Hybrid and rubber profiles

e.g. screen whippers and spoilers, guide rails, planks, slide rails...

Metal sheets

e.g. metall plates, reflector plates, claddings...

Plates and Panels

e.g. particle and chipboard, MDF, HDF, OSB, gypsum and plaster board, insulation boards, furniture panels...

Winding Cores

e.g. for foils, adhesive tape, paper...

Rods and bolts

e.g. metal, plastic, composites...



Fig. 8 - 12: Diverse spectrum of measurable objects (pipes, hoses, profiles, plates, boards, ...)

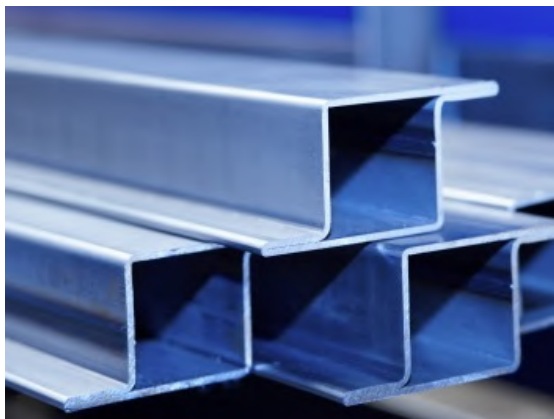
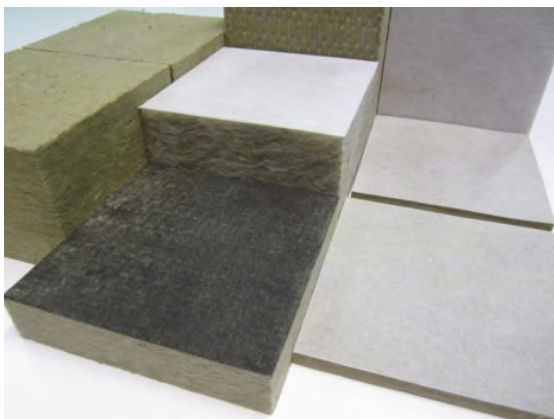
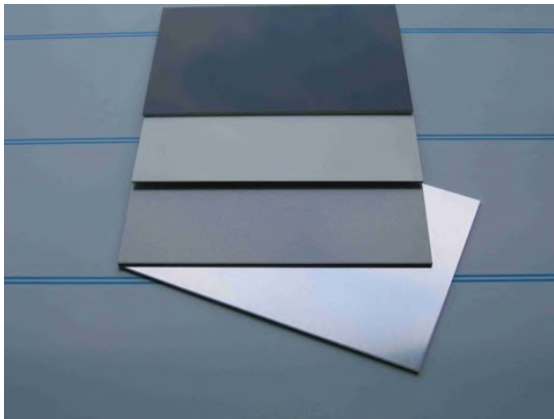

Features

High accuracy

From $\pm 0,1$ mm at short lengths, up to $\pm 0,5$ mm at ~ 5 m part length.

100% Length inspection

Measuring during material transportation after cutting ensures 100% inline monitoring of the complete production lot.

100% Process documentation

SLM ensures a constant delivery quality and documentation for the customer.

Sorting by length

SLM-SPS automatically sorts, depending on individual customer and product tolerances, in good and waste or by different lengths in designated containers.

Flexibility

Unlike camera based systems, SLM does not have to be configured for different lengths. Every part length up to the maximum length range of the SLM gauge is measured reliably.

Time saving during start-up

Thanks to direct in-line length measurement, the operator can save time while setting the target length.

Waste reduction

Thanks to immediate inline measurement and optional feedback to the cutting unit for cut optimization waste can be reduced strongly.

Prevention of manual errors

Individual operator influences and mistakes in manual length measurements are eliminated.

Maintenance-free

SLM is maintenance-free and permanently calibrated.

Amortisation

Usually the SLM-System pays off in very short time. Especially with high quality materials and high demands, such as in automotive, furniture or medicine industry, a payoff time of less than one year is typical.

System Extensions

The SLM length measuring system can optionally be extended by additional sensors and system technology:

Width, thickness measurement

via optical scanning of the side edges

Squareness, parallelity measurement

via scanning of the material edges

Height, diameter measurement

by measurement of the material cross-section

Volume determination, meter weight

by cross-section measurement and integration of a load cell

Material handling

conveyor belts, roller conveyors, slides, guides

Control and sorting technology

control technology, good/waste sorting, ejectors, pushers, switches

Automation technology

for parts handling, linear units, robot solutions

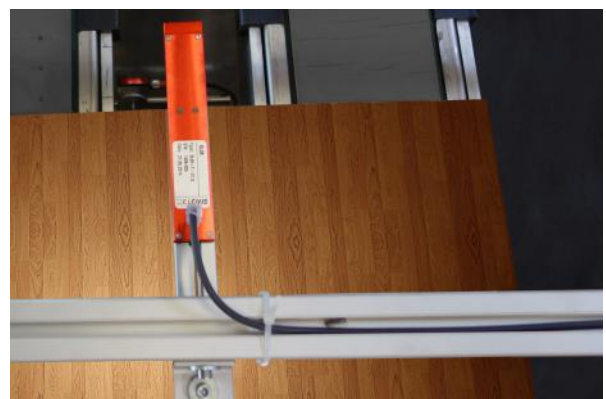
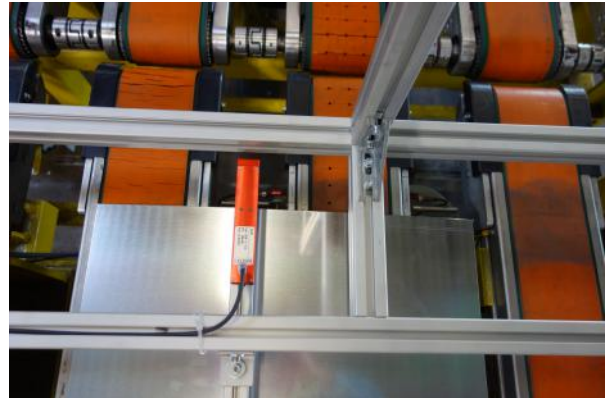

Fig. 13 - 16: SLM - application examples and examples for different sensor positioning

Accessoires

Sensor cable

- 10m or more

Bus Coupler

- Profibus-DP
- Profinet-RT
- Ethernet-IP

SLM Box

not intended for permanent installation!

- Power supply for SLM
- Serial interface for PC connection

PC software CMS

intended for set-up operation or when fitting manual measuring stations!

- Display and recording of measurement series
- trend display of the last 20 measurements
- Export of measured data as CSV file possible

Other Accessories

may be offered depending on the currently available capacities:

- PLC sorting control
- Conveyor technology and sorting technology
- Leadership solutions
- protective housing

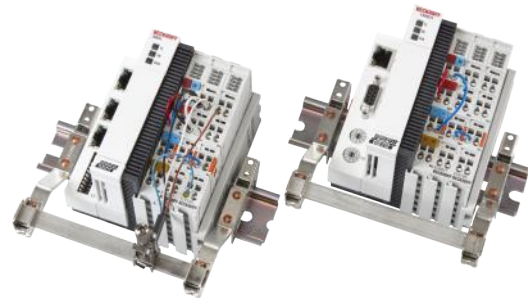

Fig. 17: Profibus, Profinet, Ethernet Module



Fig. 18: SLM Box

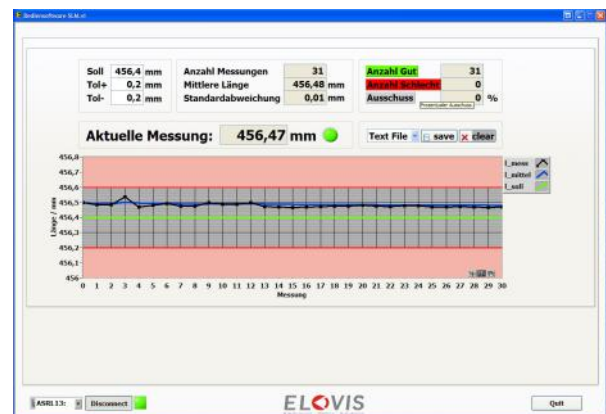

Fig. 19: PC software for display of values and tendency including data logging



Fig. 20: SLM-SPS sorting control

Technical Data

		SLM	SLM/2	
Parameters	Unity			Note
Object speed	m/s	0,01 - 4		V _{max} depending on measurement range
Measurable discrete part length	mm	10 - 4860	10 - 4500 plus offset length "x"	L/SLM/2 up to 15 m, e.g. 3 m to 7,5 m or 10 m to 14,5 m
Separation	mm	> 10		Gap between two objects
Systematic accuracy	mm/m	+- 0,1		Typical
Repeating accuracy	mm	+- 0,03		1 sigma
Distance transmitter /receiver	mm	150 - 1000		Larger distances on request
Light source		IR-LED		
Wavelength	nm	850		
Operating voltage	V	12 - 30		
Power input	W	12		
Interface type		RS - 485		Half-duplex
Data rate	kbit/s	115200		8N1
Fieldbus-Options		Profibus		Optional
		CANopen		On request
		DeviceNet		On request
		CC-Link		On request
		Ethernet - IP		On request
		Profinet IO		On request
		Modbus- RTU		On request
Dimensions (cross section)	mm ²	30 x 30		System profile with 8 mm slot
Connection		M8 connectors		
System length L	mm	200-4961	Depending on the desired measurement length	
Weight	kg/m	1		Per array (transmitter and receiver)
Mounting		Via slot nuts		
Ambient temperature	°C	-10 bis +45		
Protection class		IP50		Higher IP on request

Electrical connection

Receiver

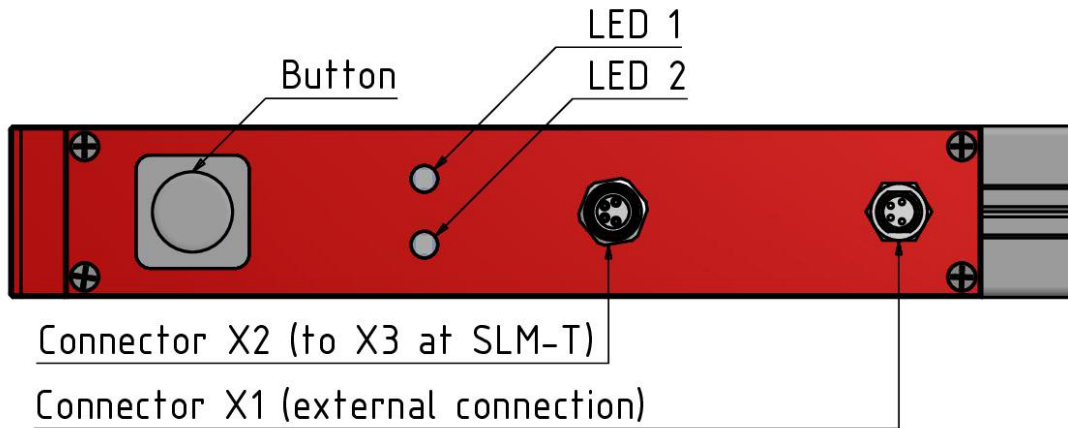

Transmitter

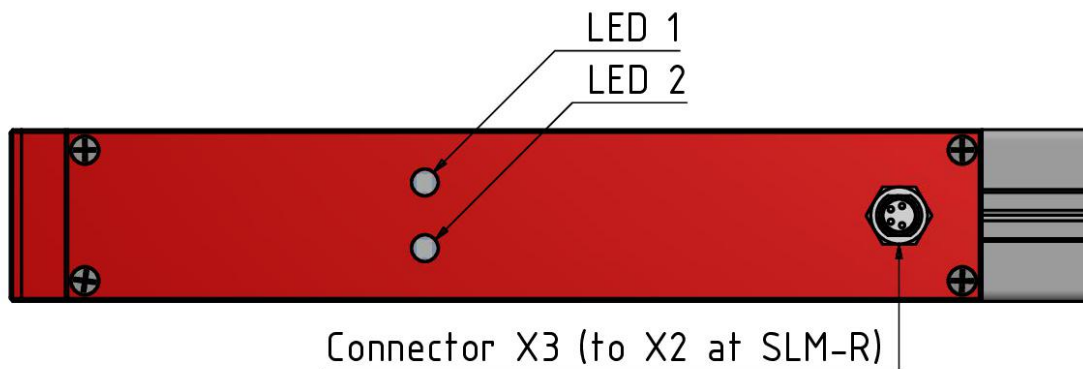

Pin assignment connector cable X1

Pin	Color	Signal
1	Brown	VCC
2	White	RX/TX-
3	Blue	GND
4	Black	RX/TX+



Fig. 21: Electrical connection - SLM system and pin assignment of the connection cables

Dimensional Drawing Plug Connect

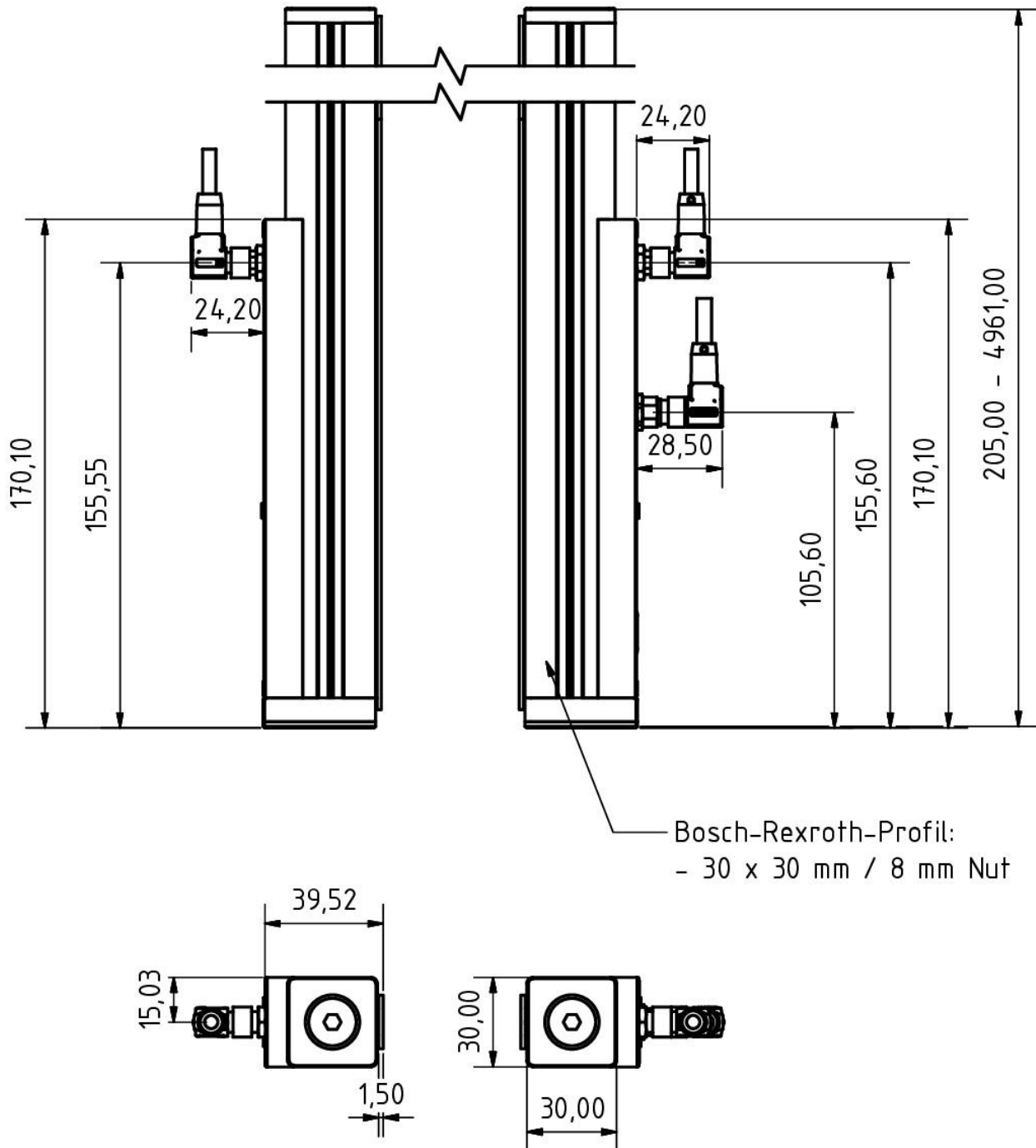

Fig. 22: Dimensions plug connect - SLM System

Dimensions Complete System

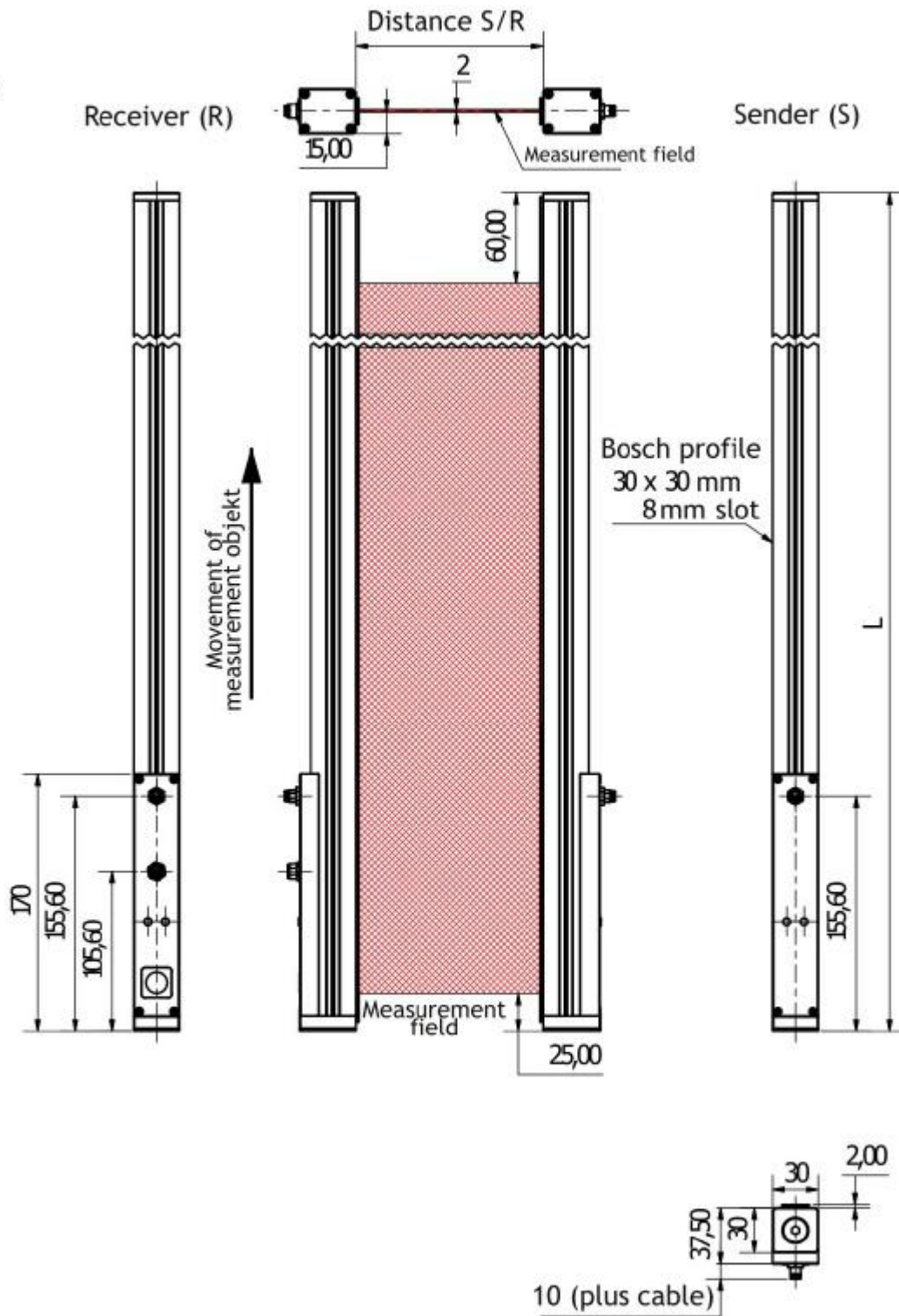

Fig. 23: Dimensions of complete system - SLM

System Types

SLM

Standard SLM gauges are currently available for measuring length ranges from 0.126 m to 4.860 m and corresponding total lengths [L] from 0.205 m to 4.961 m in the following gradings.

Type	SLM			SLM/2	
	Measurement Range [mm]	N	L [mm]	Dynamic Measurement Range SLM/2 part B [mm]	L SLM/2 [mm]
SLM-L0.1	10 - 126	0	205	0	0
SLM-L0.4	10 - 472	3	575	273	400
SLM-L0.8	10 - 838	7	940	639	766
SLM-L1.2	10 - 1203	11	1305	1004	1133
SLM-L1.5	10 - 1569	15	1670	1370	1499
SLM-L1.9	10 - 1935	19	2035	1736	1866
SLM-L2.3	10 - 2301	23	2405	2102	2232
SLM-L2.6	10 - 2666	27	2770	2467	2599
SLM-L3.0	10 - 3032	31	3135	2833	2965
SLM-L3.3	10 - 3398	35	3500	3199	3332
SLM-L3.7	10 - 3764	39	3865	3565	3698
SLM-L4.1	10 - 4130	43	4230	3930	4065
SLM-L4.4	10 - 4495	47	4596	4296	4431
SLM-L4.8	10 - 4860	51	4961	4662	4798

SLM/2

SLM/2 gauges generally consist of two subsystems, each connected by cables. The partial sensor A for detecting the material end edge is a SLM-L0.1 gauge with additional plug connection and a measuring range of 126 mm. This partial sensor is 205 mm long. The partial sensor B for detecting the leading material edge is available in different lengths from 0.4 m + x up to max. 4,5 m + x. The offset length "x" stands for the distance between subsystem A (SLM-0.1) and subsystem B. This makes it possible to measure discrete part materials from 3 m to 7.5 m or from 10 m to 14.5 m, for example. The SLM/2 system components are pre-calibrated at the factory. However, the SLM/2 system as a whole is not calibrated until it is installed on site using reference parts.



ELOVIS

ELOVIS GmbH
Karl-Friedrich-Straße 14-18
76133 Karlsruhe
Germany

Tel.: +49 (0)721 933823 0
Fax: +49 (0)721 933823 23

info@elovis.de
www.elovis.com